

44mm Fire Door

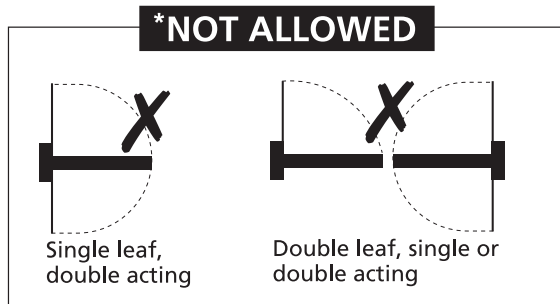

CF160 / CF192 FD30 Fire Door Installation Instructions

This door is to be installed as FD30 Doorset.
Maximum leaf size 2040mm x 926mm.

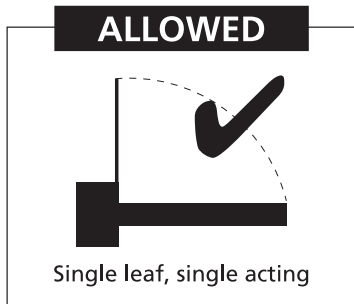

	CF 160 A12345 JELD-WEN UK Ltd Tel: 0845 122 2890	Fire Door Certification invalid unless installed and maintained exactly in accordance with Manufacturer's instructions and this label is retained unmarked and not removed.	CERTIFIED FIRE DOOR <small>DO NOT REMOVE LABEL</small>	FD 30
NEVER REMOVE THIS TAMPER EVIDENT LABEL FROM THE TOP EDGE OF THE DOOR LEAF				

Installation Instructions

All Dimensions are in Millimetres (mm)

1. Door Frame

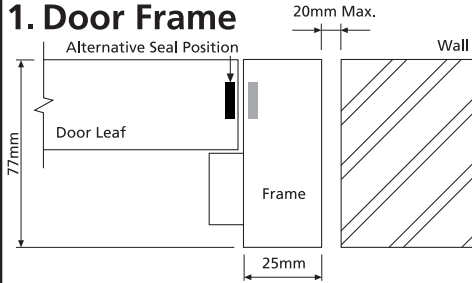

The frame to wall gap must be filled with stone wool or sealed with intumescent mastic if less than 6mm wide.

2. Hinge Position & Fixing Locations

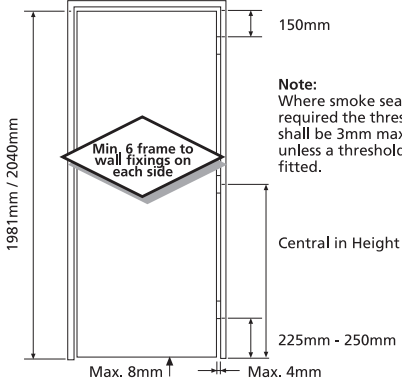

Note:
Where smoke seals are required the threshold gap shall be 3mm maximum unless a threshold seal is fitted.

Measure from the top of the floor covering to the underside of the door.

3. Trimming of the door

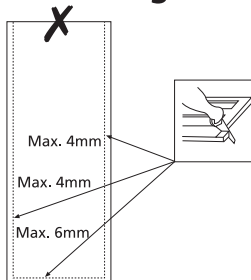

4. Door Seals



certifire Any CERTIFIRE approved intumescent

5. Hinges & Screws

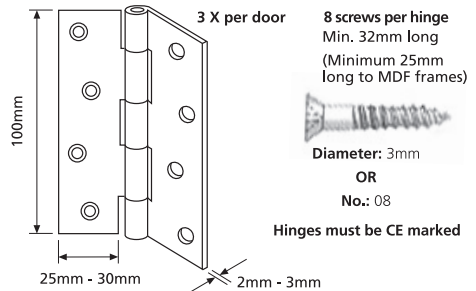

6. Lock or Latch

All dimensions are maximum.

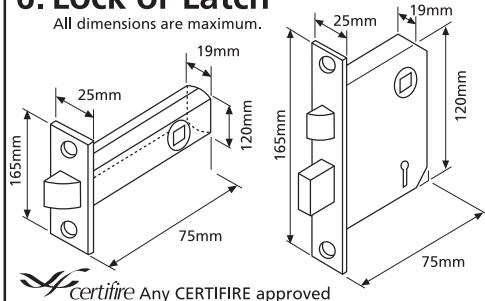

certifire Any CERTIFIRE approved

7. Door Closer

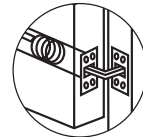
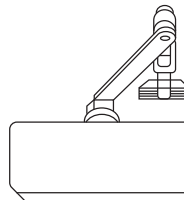

Jamb mounted closer may be used on internal doors to dwelling with single family occupancy. Fix central in mid-rail in all moulded faced doors.

certifire Any CERTIFIRE approved to BS EN 1154